



TOSHIBA

Small Scale Geothermal Power Plant



Toshiba Energy Systems & Solutions Corporation

Power Systems Division

72-34 Horikawa-cho, Saiwai-ku, Kawasaki, Kanagawa 212-8585, Japan
<https://www.toshiba-energy.com/en/index.htm>



* You can also visit our website
by scanning the QR code.

Issued October 2021

3119-2 22-01

● Any personal information you provide in the context of your query will be used only to reply to your questions.
Privacy policy: <http://www.toshiba.co.jp/privacy/index.htm>

● All information herein is subject to change without notice, including product specifications.

INDEX

- 03 Philosophy
- 04 Potential Concern / Solution by Geoportable™, Early Completion / Simple & Easy O&M
- 06 Key Features, Technology & Benefit / Geothermal Steam Turbine Product Line-up
- 08 GXP-2B
- 10 GXP-2C
- 12 GXP-5C
- 14 GXP-X
- 16 Geothermal Steam Turbine / Generator
- 18 Turbine & Generator Controller TOSMAP-DS™/LX
- 20 Excellent Operation Support: IoT Solutions
- 22 World Top Level Share

Next power generation

Philosophy

Following the Paris Climate Agreement in December 2015, with 196 nations agreeing to reduce greenhouse gas emissions based on country-by-country targets, the clean and sustainable nature of geothermal power grows, making it an increasingly more attractive alternative source of energy to help achieve “Carbon Neutrality”.

As a leading global manufacturer for power generation systems, Toshiba continues to innovate and develop new solutions to help our clients meet their commitments to reducing CO₂ emissions.

One of these solutions is the Geoportable™, a small scale geothermal technology. Toshiba has a long history of manufacturing geothermal power equipment, dating back to 1966, when we delivered our first geothermal steam turbine.

Today, Toshiba enjoys the No.1 global market position based on total capacity and with the application of Geoportable™ technology, we believe that small scale geothermal power plants will play an increasingly more important role in the pursuit of carbon neutrality.

Potential Concern

- Diesel generators are the primary energy source on remote islands and other remote locations.
- Steam availability in existing wells declines over time.
- Drilling new wells requires significant time and investment.
- Longer installation and start up times of conventional geothermal power plant may lead to delays in revenue streams.

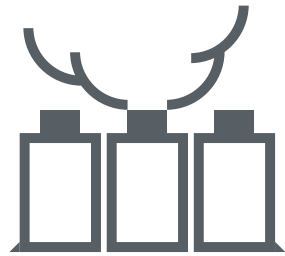

Our goal is large power generation !



We need many wells !
We need financing !

Solution by Geoportable™

Geoportable™ equipment can be installed in a shorter period, and, in many cases, using existing wells resulting in quicker power availability.

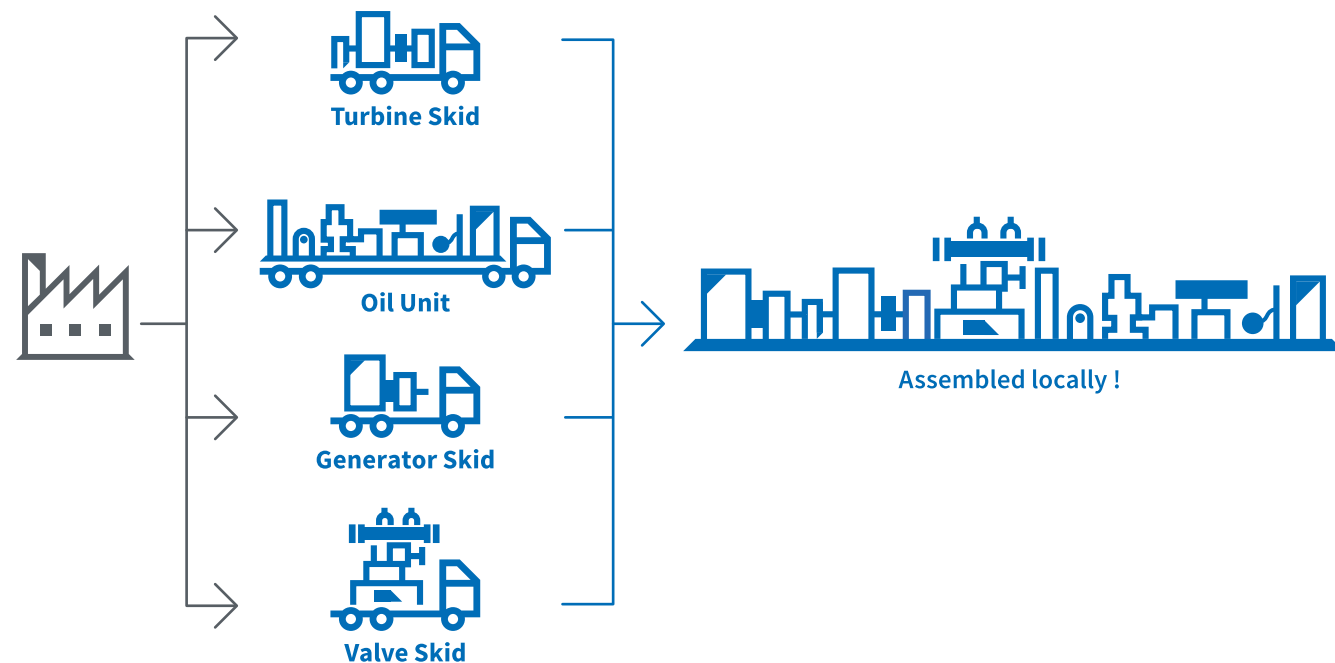

Early Completion

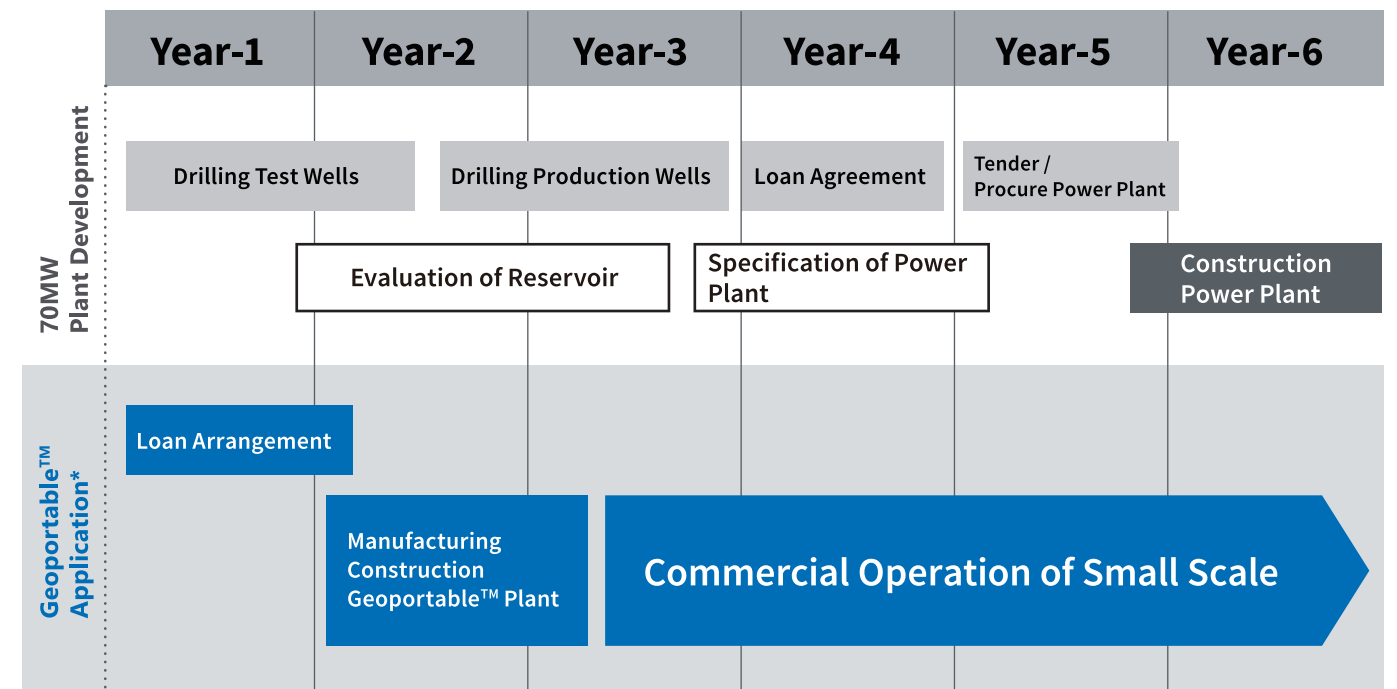

*Note: Based on assumption of utilizing idling well

Simple & Easy O&M

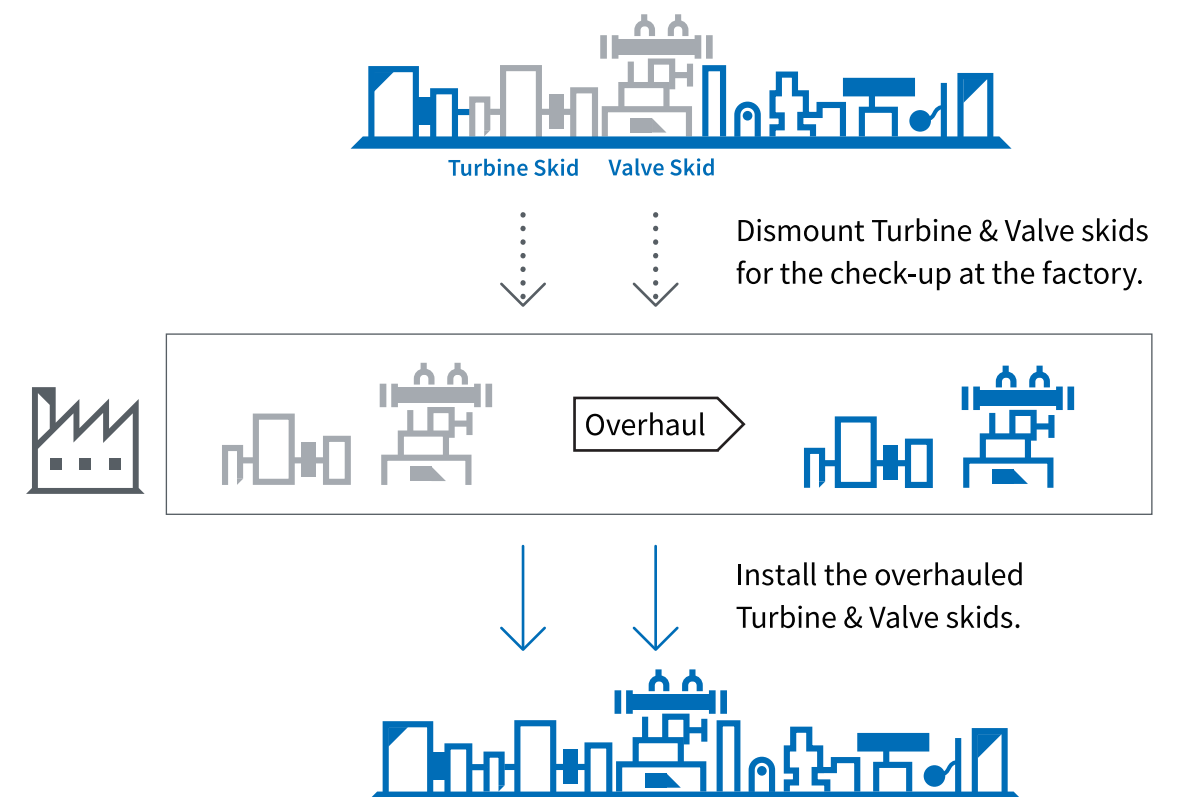

Key Features, Technology & Benefit

1

Small Footprint

Size reduction due to high speed turbine.
Reduced redundancy for each equipment.

BENEFIT Smaller Installation area.

2

Robust & High Reliability

Impulse design.
Special material for rotating parts & anti-scaling technology.

BENEFIT Stable Operation for long time & Increase in revenue.

3

Early Completion

Simple skid type design & Standard design.

BENEFIT Early revenue.

4

Simple & Easy Maintenance

Individual skid replacement.

BENEFIT Increased plant Availability.

5

Excellent Operation Support: IoT Solutions

Real Monitoring and Diagnostic system.
Plant thermal model build-up.
Analysis of Historical healthy data.

BENEFIT Sustainable Performance & Reduction of unplanned outage.

Geothermal Steam Turbine Product Line-up

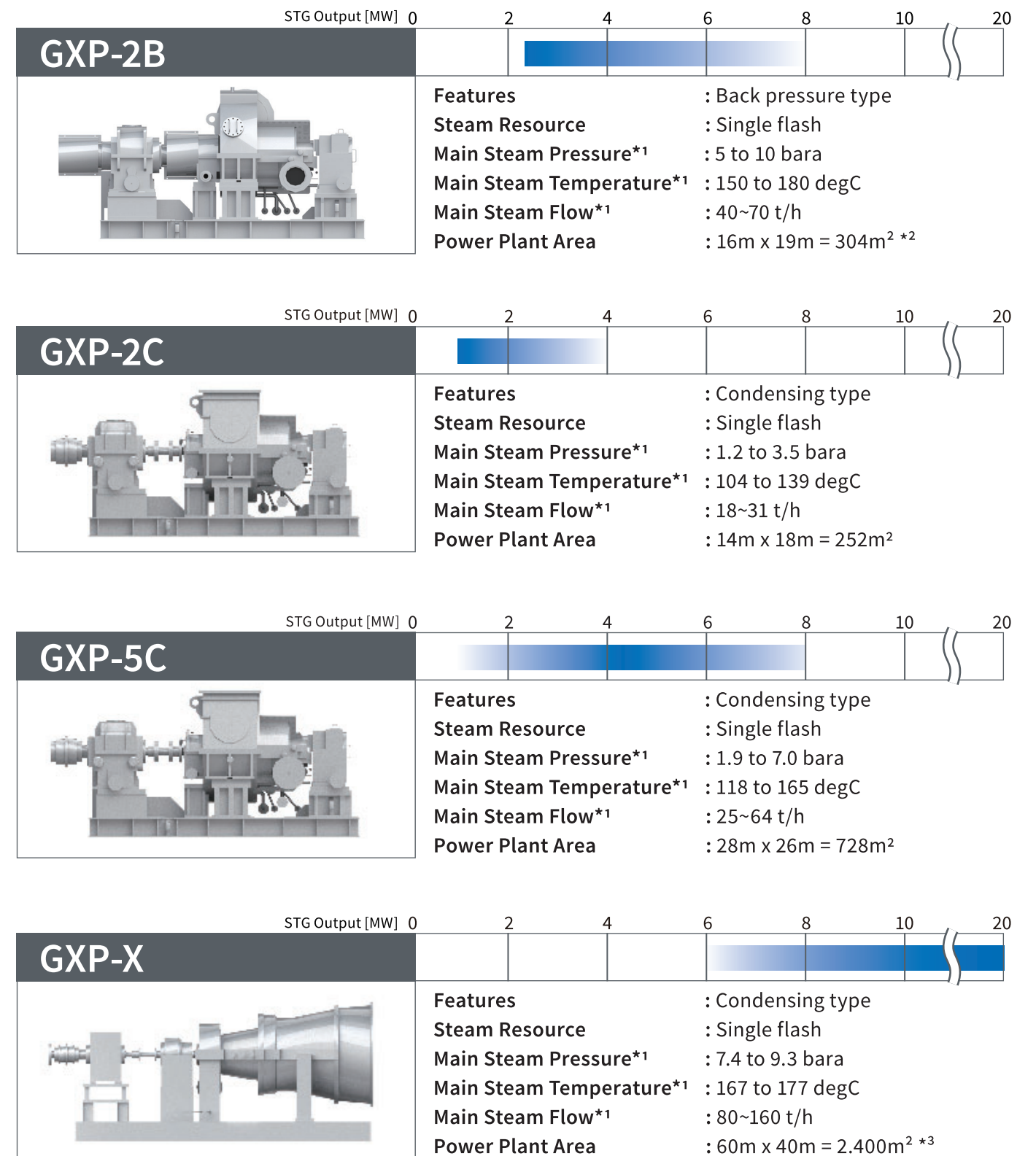

*1: Typical range

*2: STG output of GXP-2B is higher than that of GXP-2C. Therefore, the power plant area of GXP-2B is larger than that of GXP-2C.

*3: GXP-X can cover 10 - 20 MW, which is the capacity range for conventional geothermal power plant in general, meaning that the product pursues performance to maximize cost-effectiveness for customer's revenue. This is a different concept from GXP-2B/2C/5C. GXP-X can produce more than double the output of GXP-5C whilst consuming less than twice the steam flow required by GXP-5C.

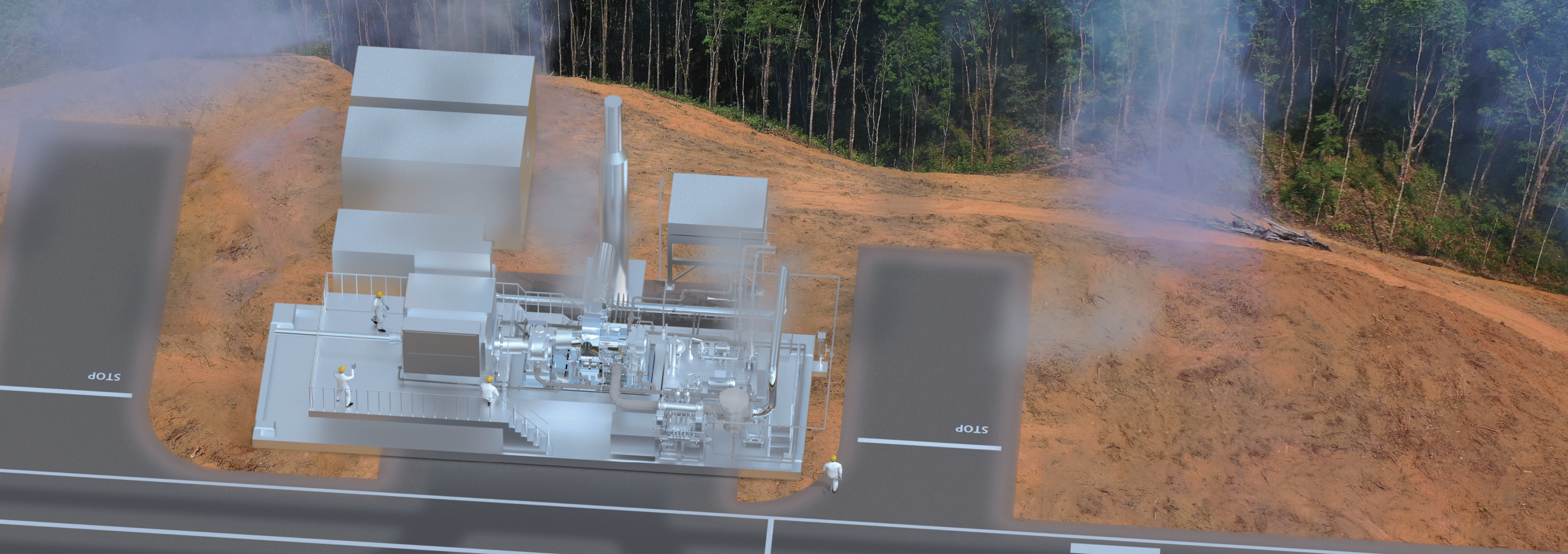

GXP-2B (Back Pressure Type)

Single Casing Side Flow

Toshiba's GXP-2B geothermal steam turbine is compactly designed and can be transported by container. GXP-2B does not require Cooling Water, thus there is no BOP system. GXP-2B is a standardized plant design which contributes to compactness, early completion and simple maintenance.

FEATURES

- Standardized Plant Design
- Skid-mounted equipment
- Less BOP system (including Condenser, Cooling Tower, Pumps)
- High reliability turbine design based on experience from long term operation

Size chart

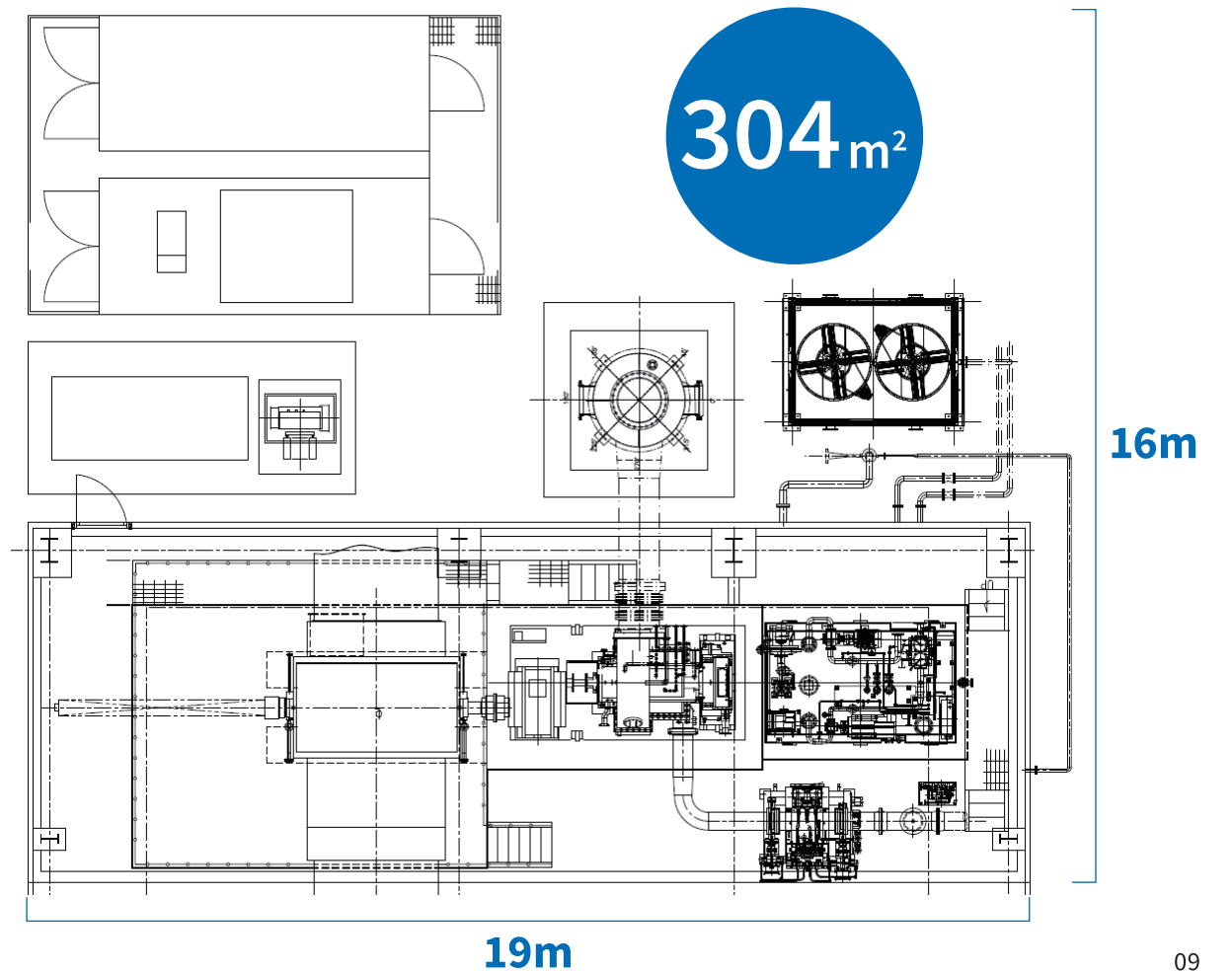
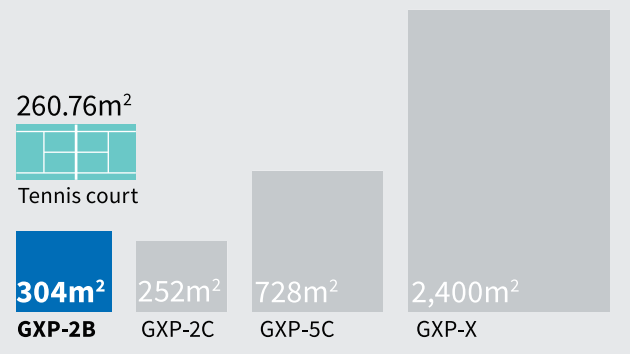

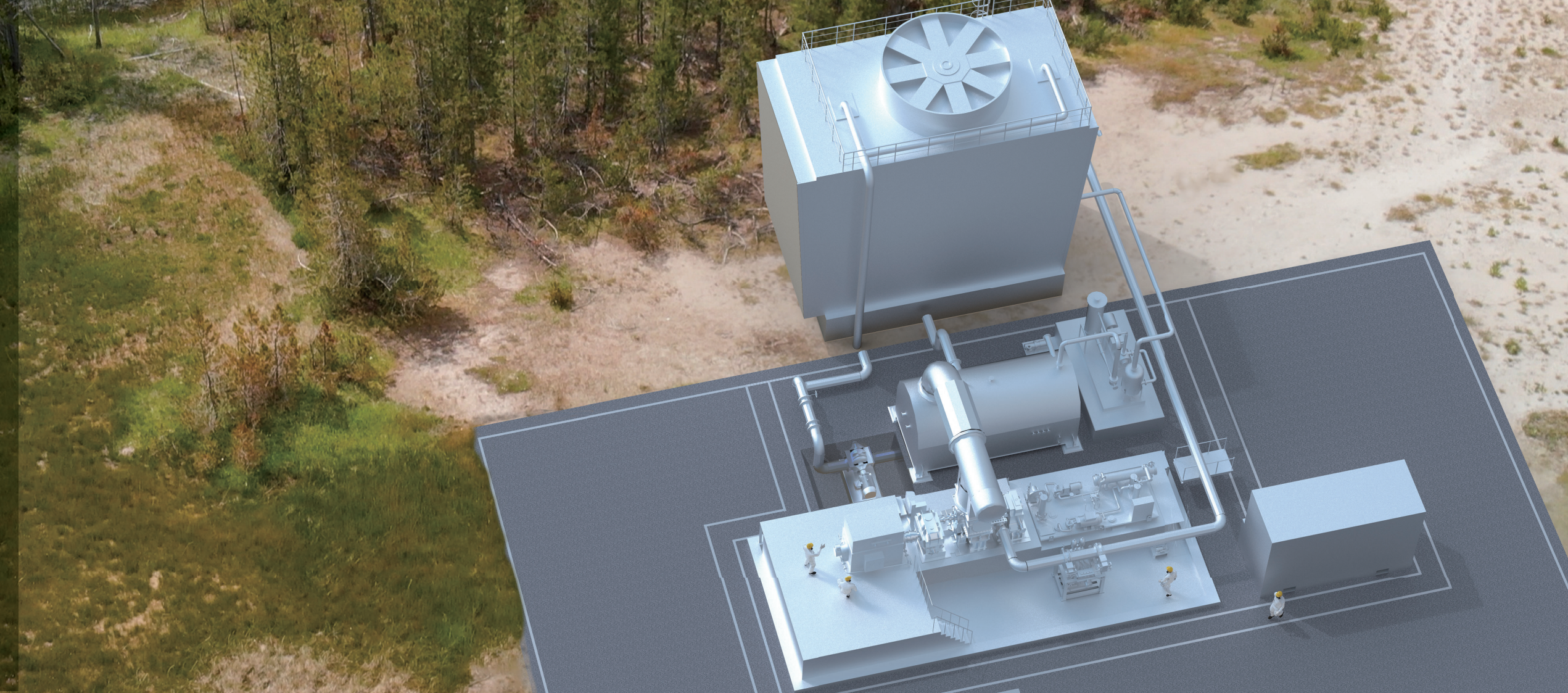

GXP-2C (Condensing Type)

Single Casing Upward Flow

Toshiba's GXP-2C geothermal steam turbine is compactly designed and can be transported by container. GXP-2C is a standardized plant design with BOP system (including Condenser, Cooling Tower, Pumps) which contributes to compactness, early completion and simple maintenance.

FEATURES

- Standardized Plant Design with BOP system (including Condenser, Cooling Tower, Pumps)
- Skid-mounted equipment
- High reliability turbine design based on experience from long term operation

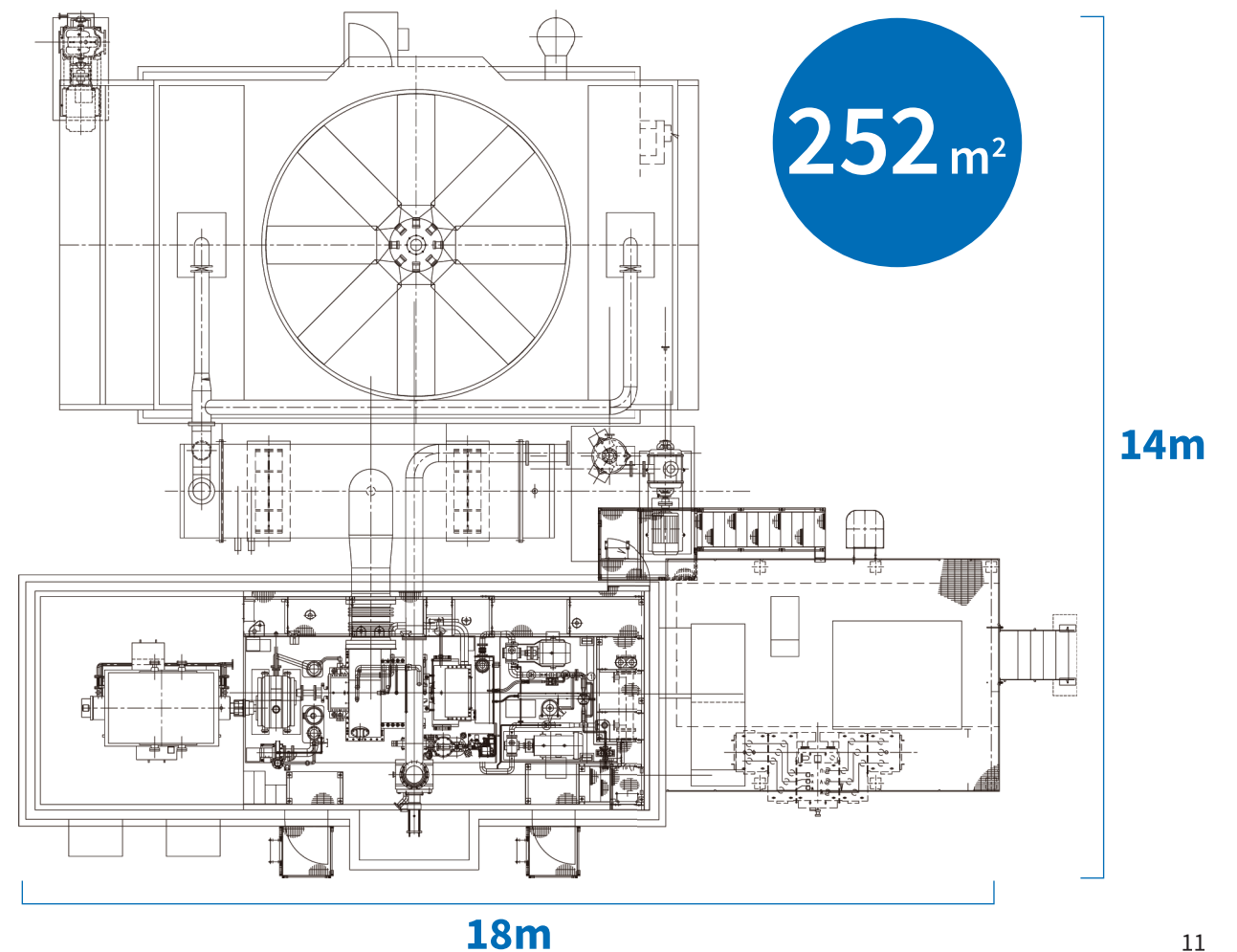
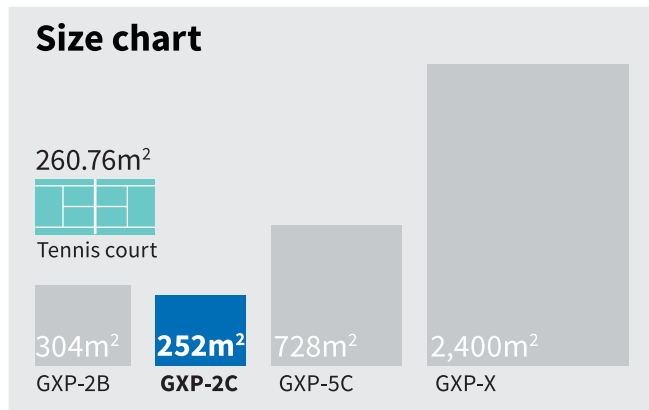



GXP-5C (Condensing Type)

Single Casing Upward Flow

Toshiba's GXP-5C geothermal steam turbine is compactly designed and can be transported by container. GXP-5C is a standardized plant design with BOP system (including Condenser, Cooling Tower, Pumps) which contributes to compactness, early completion and simple maintenance. GXP-5C has higher capacity than GXP-2C.

FEATURES

- Standardized Plant Design with BOP system (including Condenser, Cooling Tower, Pumps)
- Skid-mounted equipment
- High reliability turbine design based on experience from long term operation

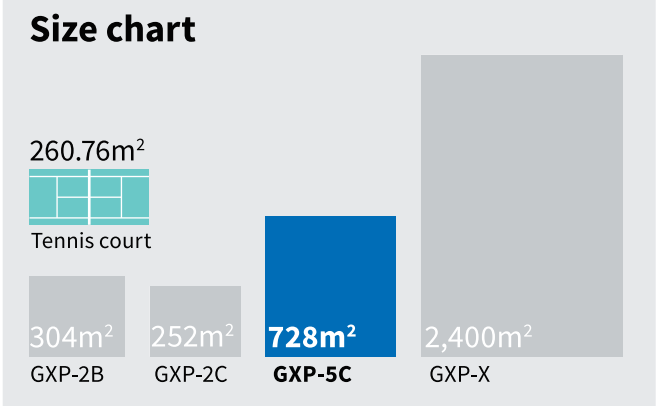

728m²

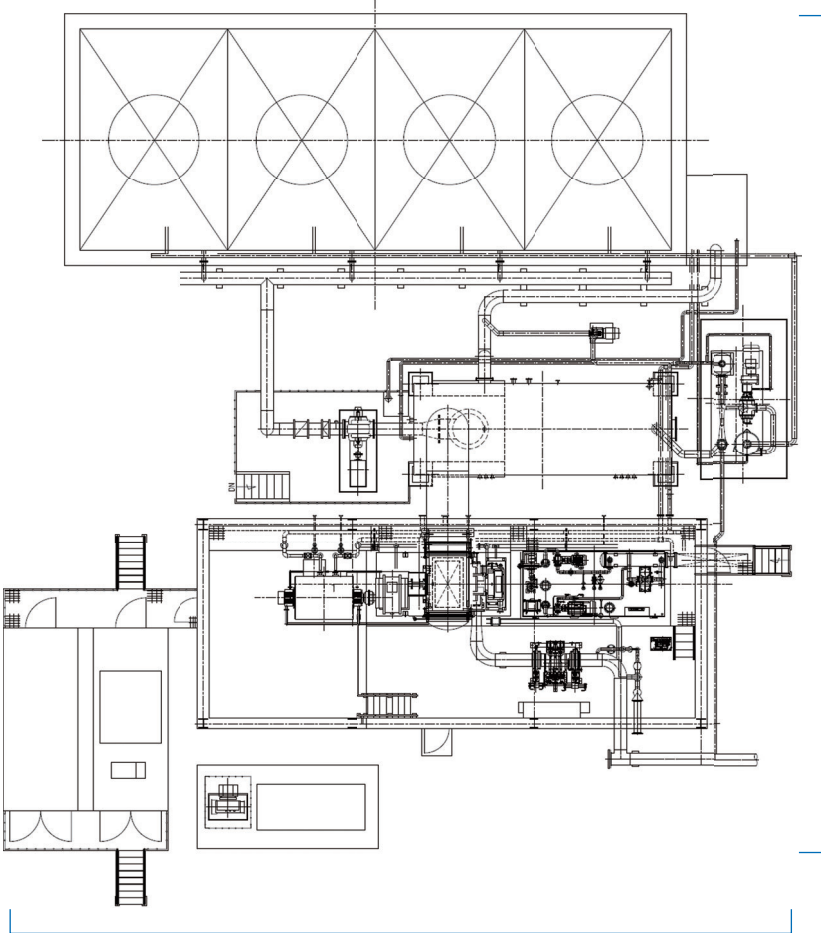

28m

26m

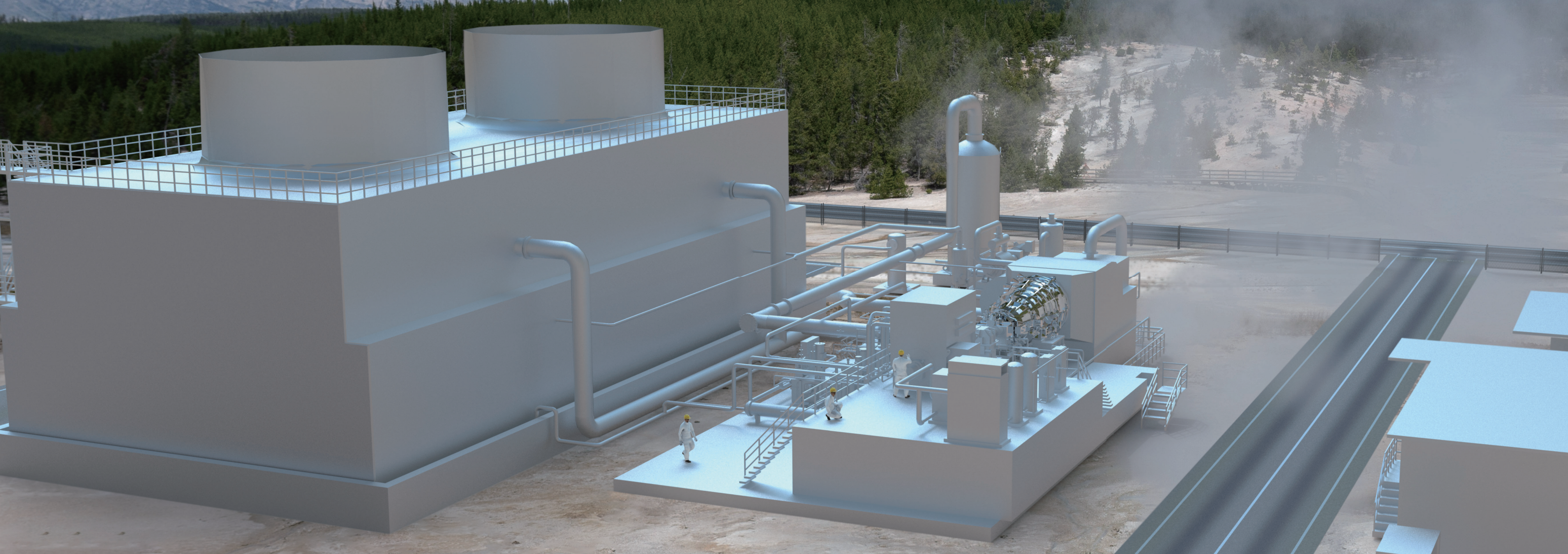

GXP-X (Condensing Type)

Single Casing Axial Flow

Toshiba's GXP-X type geothermal steam turbine is the highest capacity offering from Geoportable™ line-up, providing output of up to 20 MW. GXP-X also has the highest flexibility for steam path design to fit any type of steam conditions compared to other Geoportable™ steam turbines.

FEATURES

- High efficiency oriented design
 - Axial exhaust
 - High steam path design flexibility
- Wide capacity range 6 to 20 MW
- Skid-mounted equipment
- High reliability based on BFP turbine* design

* Boiler Feed water Pump driving Turbine in Conventional Thermal Power Plant, which Toshiba supplied to hundreds of plant.

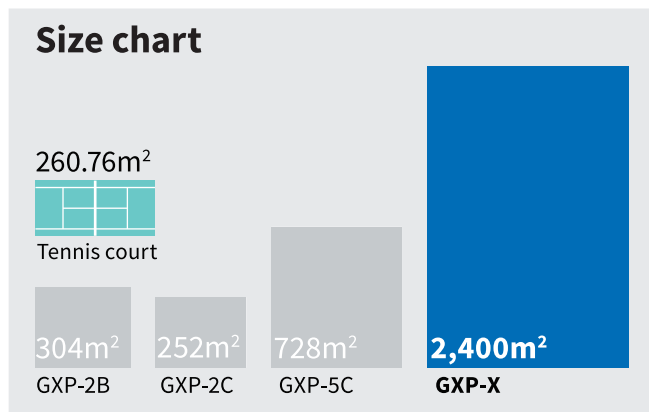

2,400 m²

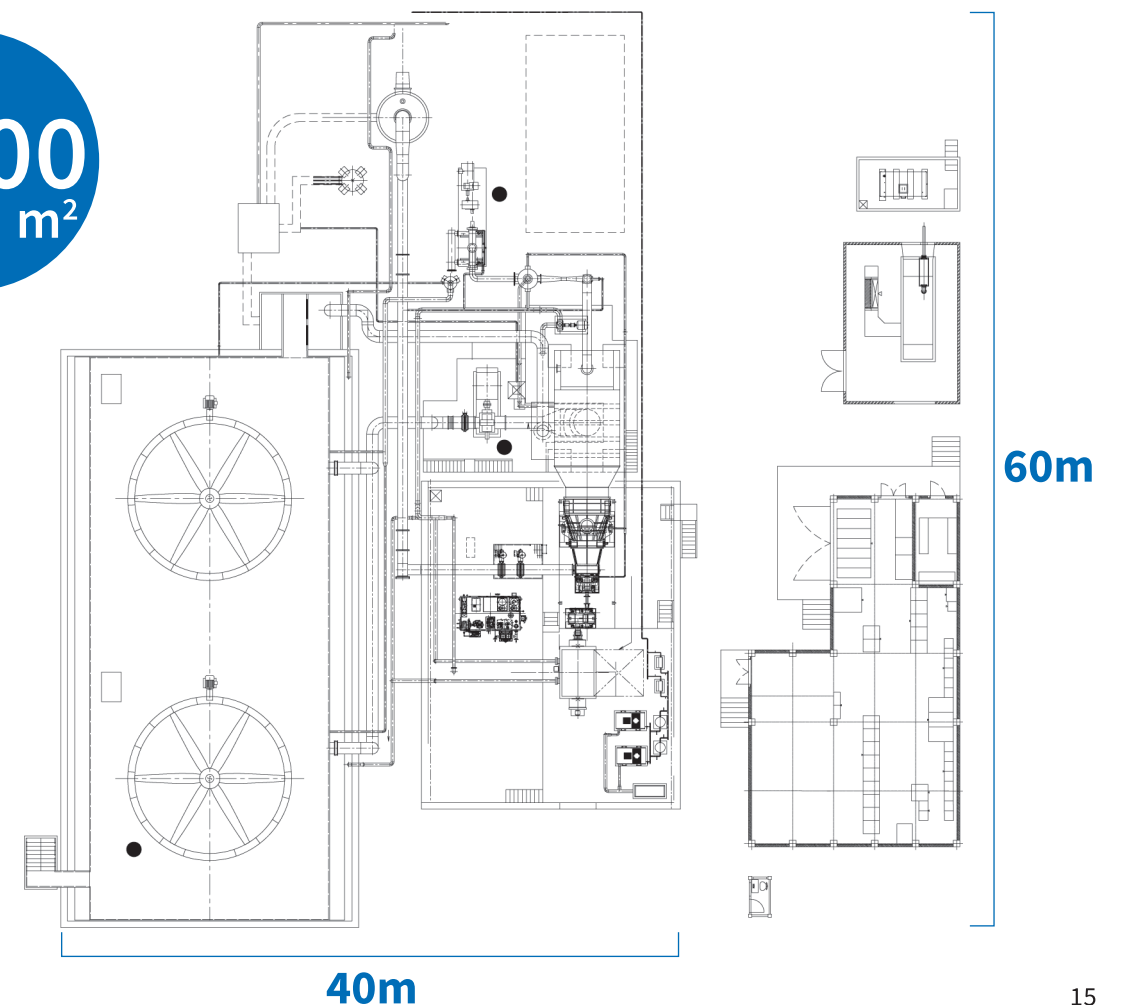

Geothermal Steam Turbine

The Impulse Steam Path design is the most suitable solution for a geothermal power plant, as it is highly efficient, easier to maintain, with less clogging caused by scaling.

High reliability and efficiency are achieved through the following design and construction features:

- Horizontal split casing
- Impulse high efficiency blading profile
- Proven blade fixture
- True centerline support of casings and nozzle diaphragms
- Solid rotor
- Less sensitive to leakage
- Fewer stages
- Wide chord nozzles and blades
- Robust blades

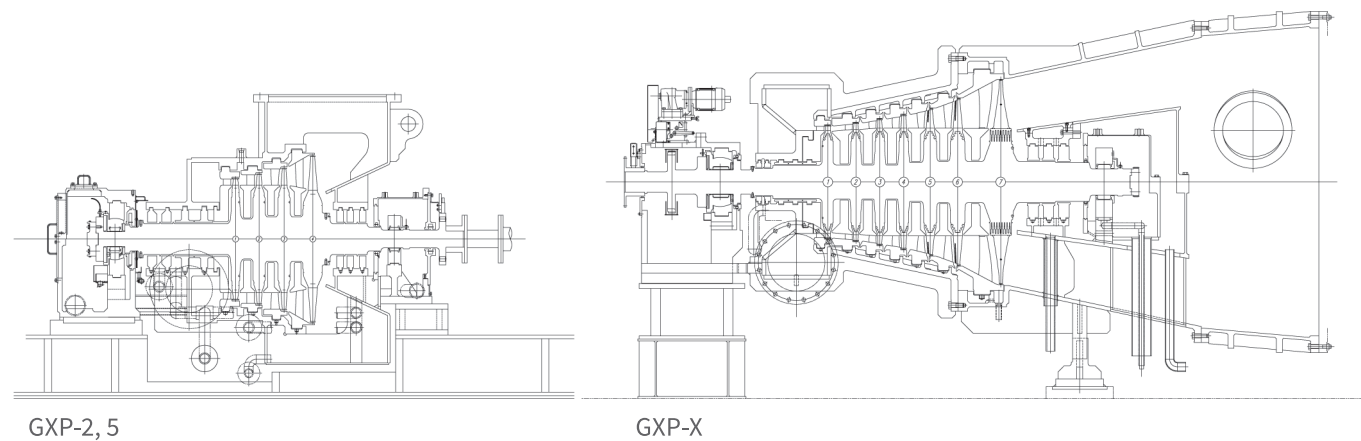

GXP-2, 5

GXP-X

Generator

Air-Cooled-Brushless Type Generator 50 Hz / 60 Hz

Air-cooled generators are designed based on cooling stator and rotor by air. The generators do not require complex sub-systems (such as stator coil water cooling systems or hydrogen cooling systems) for their proper operation. This minimizes auxiliary equipment and reduces operating costs.

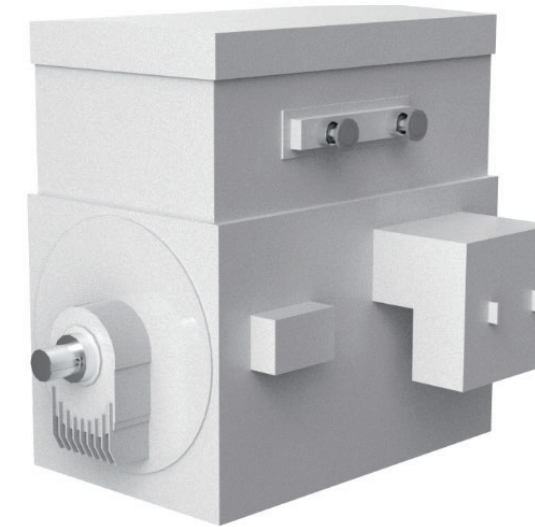

FEATURES

- Brushless type AC-exciter system with PMG (Permanent Magnetic Generator) is easy to operate and is maintenance free, allowing for continuous operation.
- Collector ring and carbon brush are not required. Therefore a clean environment (without carbon dust) can be maintained.
- The generators are designed and manufactured with countermeasures against geothermal corrosive environment including H₂S effect. Therefore, the generators can operate in H₂S environment.

Product Lineup Items	GXP-2B	GXP-2C	GXP-5C	GXP-X
Capacity	6,000 kVA	2,700 kVA	7,500 kVA	7,500 to 25,000 kVA
Power Factor	0.85	0.9	0.8	0.8 / 0.85
Output Voltage	6.6 kV	6.6 kV	6.6 kV	6.6 to 13.8 kV
Cooling Method	Air-Cooled TEAAC*1	Air-Cooled TEWAC*2	Air-Cooled TEWAC*2	Air-Cooled TEWAC*2

*1 Totally Enclosed Air to Air Cooled
*2 Totally Enclosed Water to Air Cooled

Turbine & Generator Controller TOSMAP-DS™/LX

TGCS Turbine Generator Control System

Toshiba's package TGCS includes TOSMAP-DS™/LX, (Toshiba Microprocessor Aided Power system control-Dynastream) controller hardware, a state-of-the-art microprocessor based controller specifically developed for steam turbine and generator control, to ensure stable and reliable STG operation.

TGCS is a compact integrated cabinet of Turbine Control, Power Generation Control, Turbine Protection and monitoring/alarms of Turbine/Generator and the Auxiliaries, which is easy to be installed on site with compact size and external wiring reducing.

Note Abbreviation

- TGCS : Turbine Generator Control System
- IES : Integrated Engineering Station
- SVS : Server Station
- TSI : Turbine Supervisory Instrument
- MSV : Main Steam Stop Valve
- CV : Main Steam Control Valve
- VT : Voltage Transformer
- CT : Current Transformer

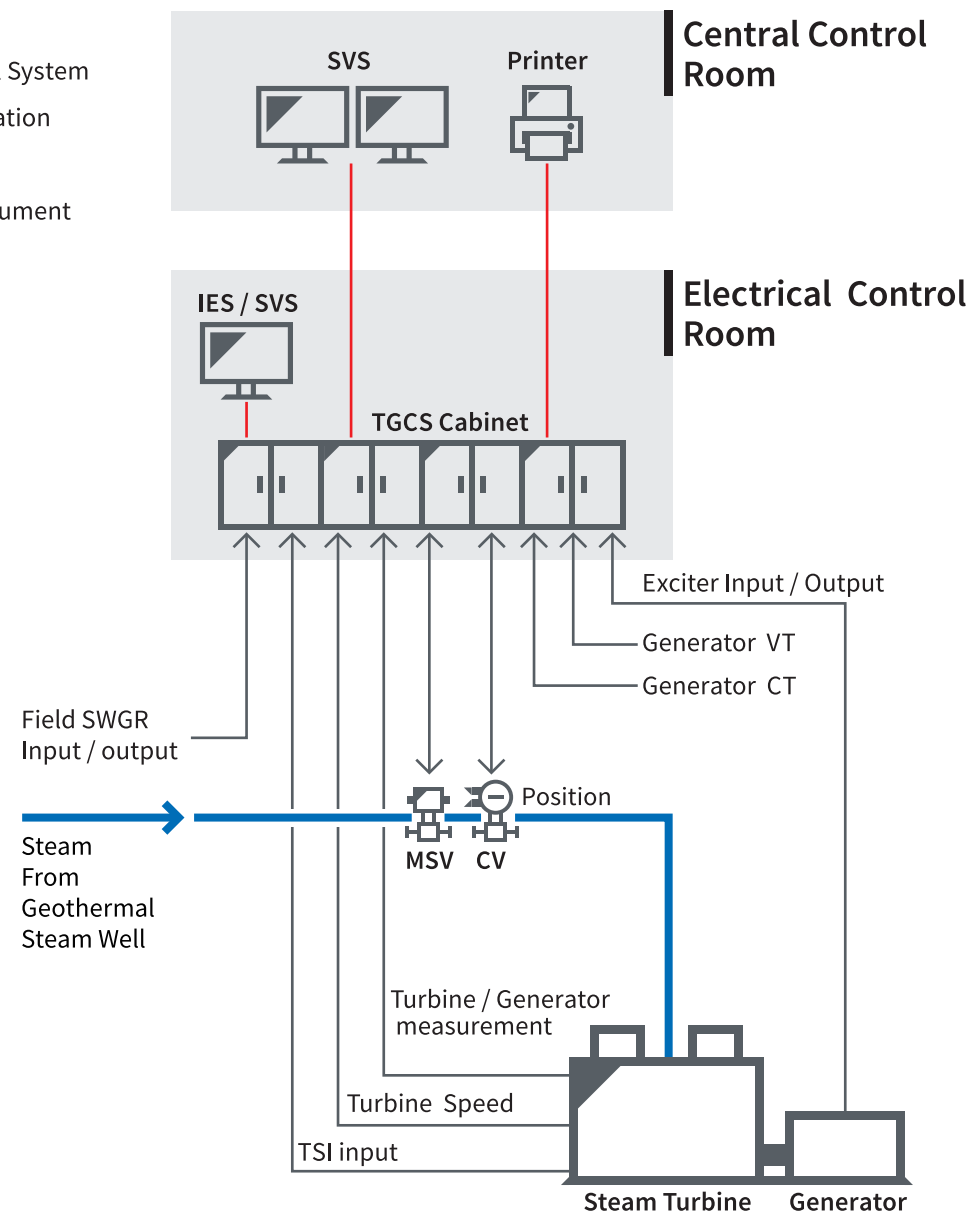

Turbine Control

Turbine Control contributes to the grid frequency stability improvement of system network by turbine speed control and load control.

Toshiba's many years of steam turbine control system design and manufacturing experience have provided us with the technological foundation to develop the latest generation Toshiba electro-hydraulic control systems. We offer the most advanced, sophisticated solution for steam turbine control.

Automatic turbine start-up

This function performs sequential automatic turbine start-up from turbine reset to target load by pressing button of each breakpoint such as "Turbine Start", "Synchronize" from SVS.

Power Generation Control

Power Generation Control contributes to the grid power stability improvement of system network by voltage control and reactive power control.

Toshiba has more than 100 years of experience in designing and manufacturing control systems for synchronous generators. We have incorporated this extensive experience and technical expertise into the design of our latest generation Toshiba excitation system.

Toshiba's expertise in generator control enables us to provide highly sophisticated, reliable and profitable Power Generation Control not only for Toshiba turbine generator but also for generators of other manufacturers.

Turbine/Generator Auxiliaries and BOP control

Turbine Auxiliaries control and BOP control such as Hot Well Pump, Vacuum Pump, Cooling Tower Fan, Condensate Pump etc., are executed in TGCS.

Turbine Protection

Turbine protection function contributes to detection of dangerous conditions of turbine and automatic stop operation of turbine by closing Main Steam Stop Valve(MSV).

Monitoring and Alarming

- Turbine/Generator Temperature, Pressure etc.
- Exciter signals
- Turbine Supervisory Instrument(TSI)

The operating conditions can be monitored such as the rotation speed, eccentricity, vibration etc., for stable operation of the turbine generator.

Excellent Operation Support: IoT Solutions

Toshiba provides IoT solution for real time monitoring and diagnostic system of geothermal plant operation , utilizing EtaPRO™ software package “Virtual Plant” and “Advanced Pattern Recognition”.

Thermodynamic Performance Monitoring

This function is to monitor performance at multiple points by comparing and checking deviations between Plant Thermal Model based data and actual performance data, which contributes to detection of deteriorated points to sustain performance.

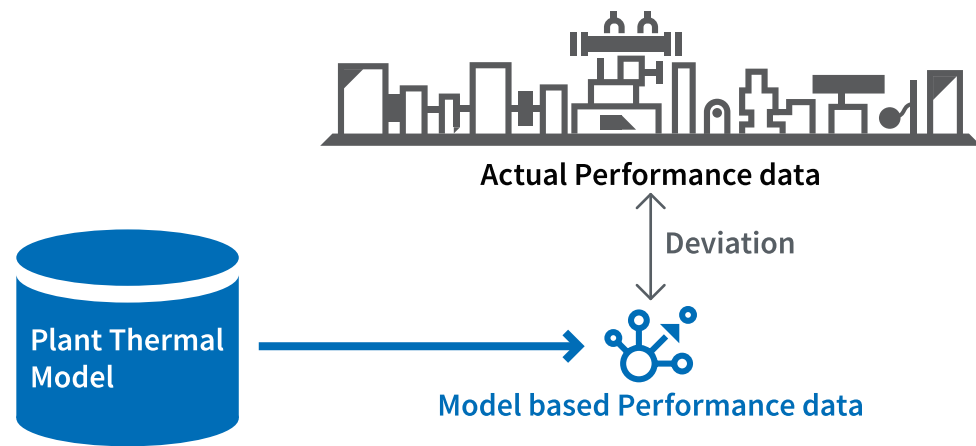

Equipment Predictive Analysis

This function is to detect abnormalities of operation data predictively before reaching a fatal failure, comparing with the real time expected value and threshold based on historical healthy data, which contributes to reduce unplanned outage by avoiding system fatal failure .

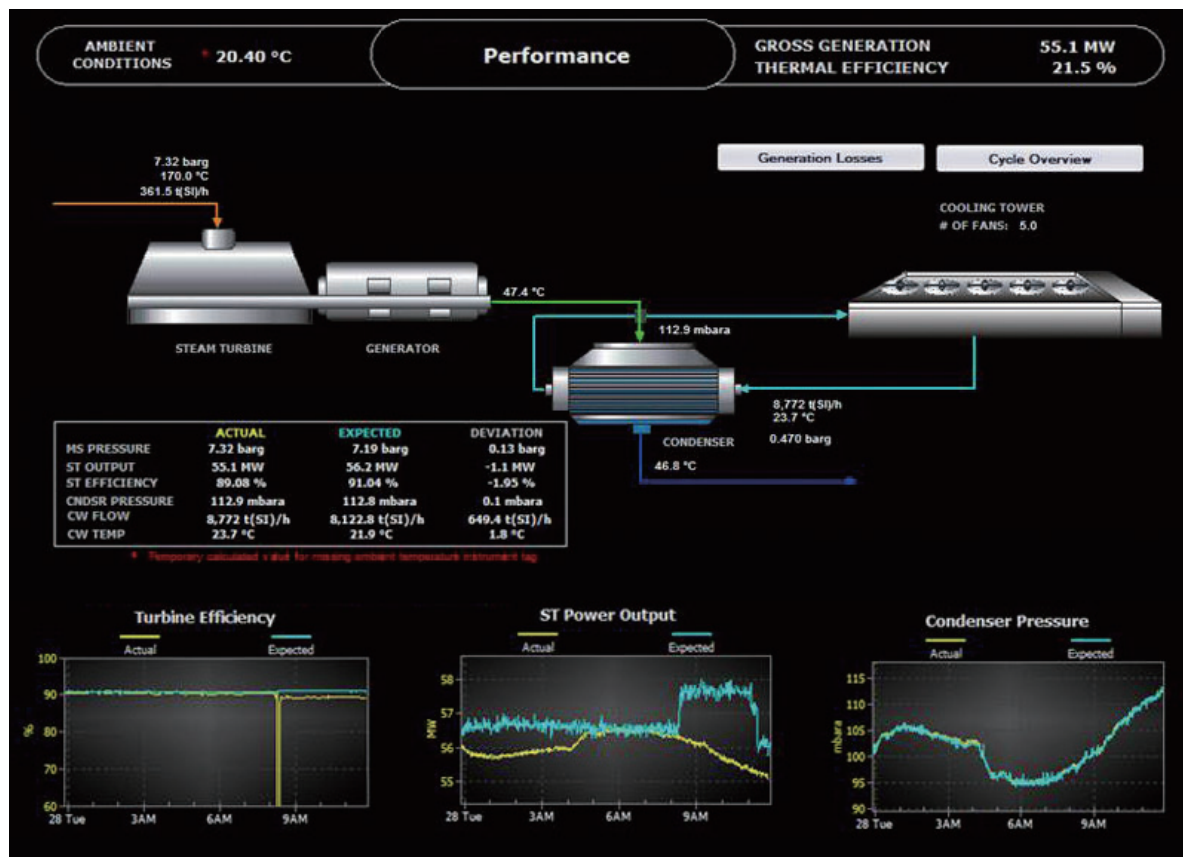
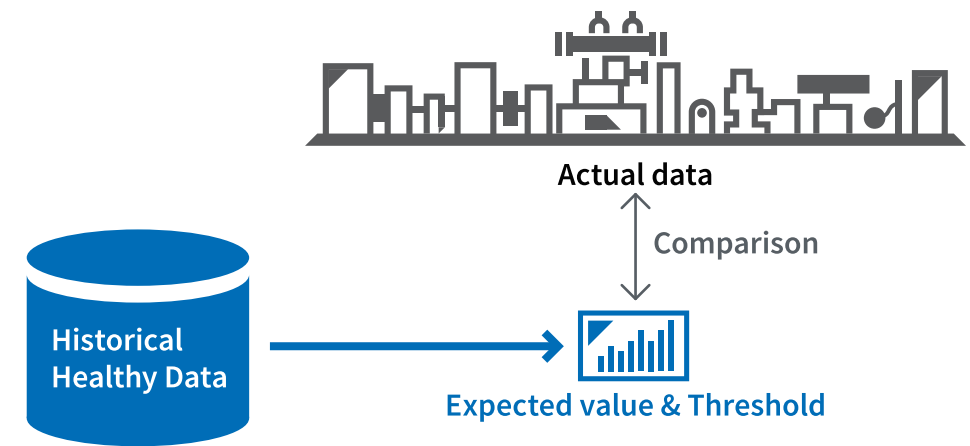

Thermodynamic Performance Monitoring Display (sample)

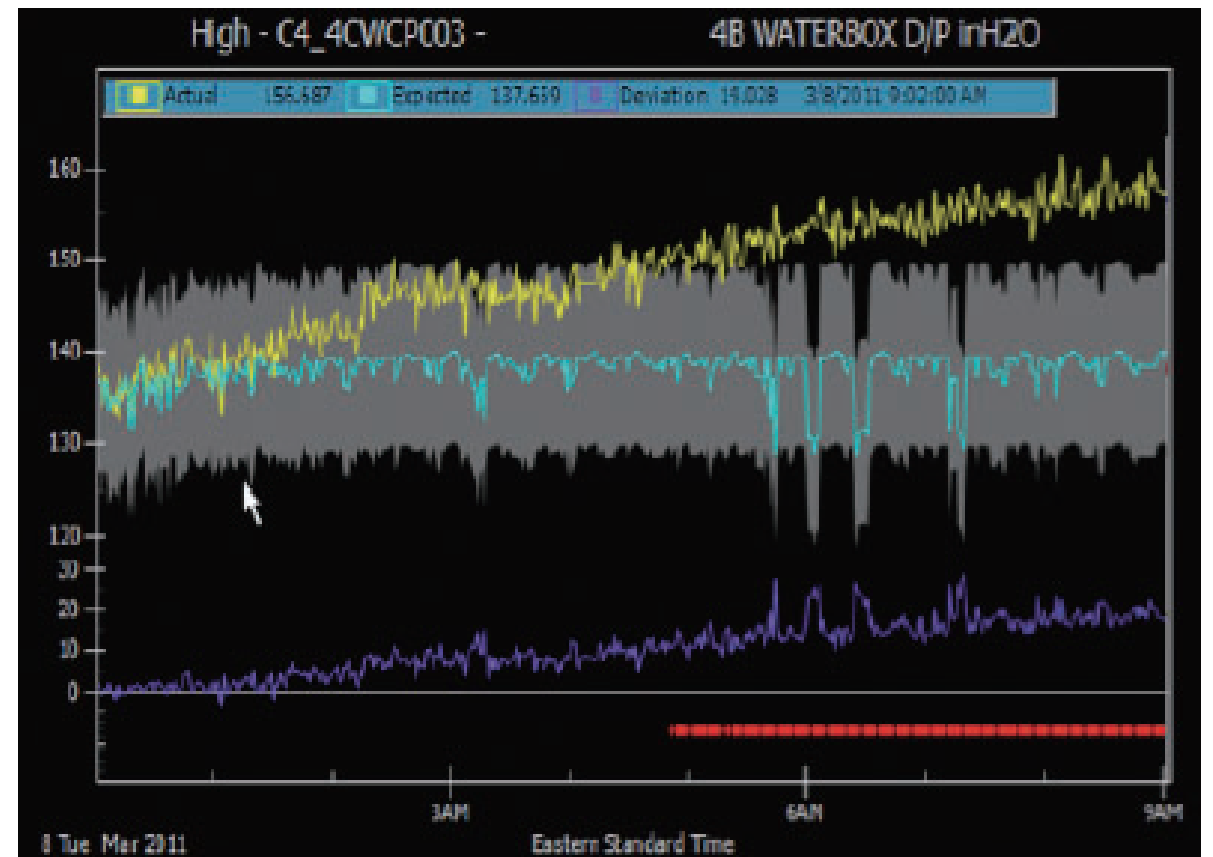

Equipment Predictive Analysis (sample)

World Top Level Share*

Installed Turbines: 60 Units, 3,791 MW since 1966 as of August 2021

*capacity based

Small Scale Geothermal Power Plants



A Waita Geothermal Power Plant, 2 MW
Kumamoto, Japan



B Dieng Small Scale Geothermal Power Plant, 12.6 MW
Wonosobo, Indonesia



C Los Azufres Geothermal Power Plant VI, 5 MW
Michoacan, Mexico

